

3 way Manifold

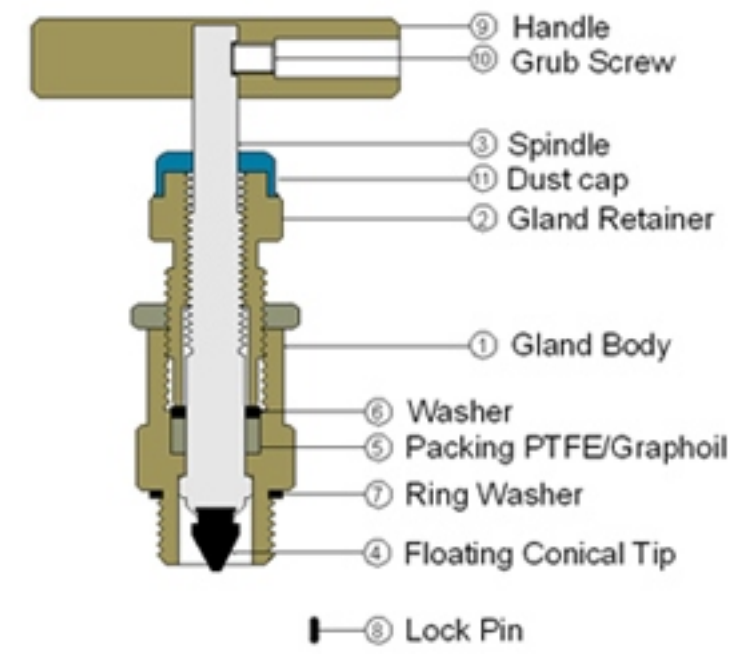

TEST PRESSURES

	HYDRAULIC	PNEUMATIC (NITROGEN)
BODY	9000_PSI	1000_PSI
SEAT	6600_PSI	1000_PSI

TECHNICAL FEATURES :

- Working pressure: 6000 PSI
- Temperature rating : PTFE 450°F (232°C).
- Material of construction :SS 316.
- Stem packing :PTFE.

BONNET ASSEMBLY:

- Screwed Bonnet design.
- Spindle tip -Non rotating vee tip shut off type
- Spindle-Rolled thread type
- Bonnet pusher - Duly machined for smooth stem cycle.
- Dust cap - Protects stem threads from external contamination.

TESTING :

- Hydrostatic shell test is performed AT 1.5 TIMES the working pressure.
- Optional(helium/nitrogen) tests are available on request.

CLEANING & PACKAGING:

- All components are ultrasonically cleaned prior to assembly & testing.

NOTE: Different End connections and Material grades offered on request. All valves are 100% factory tested.

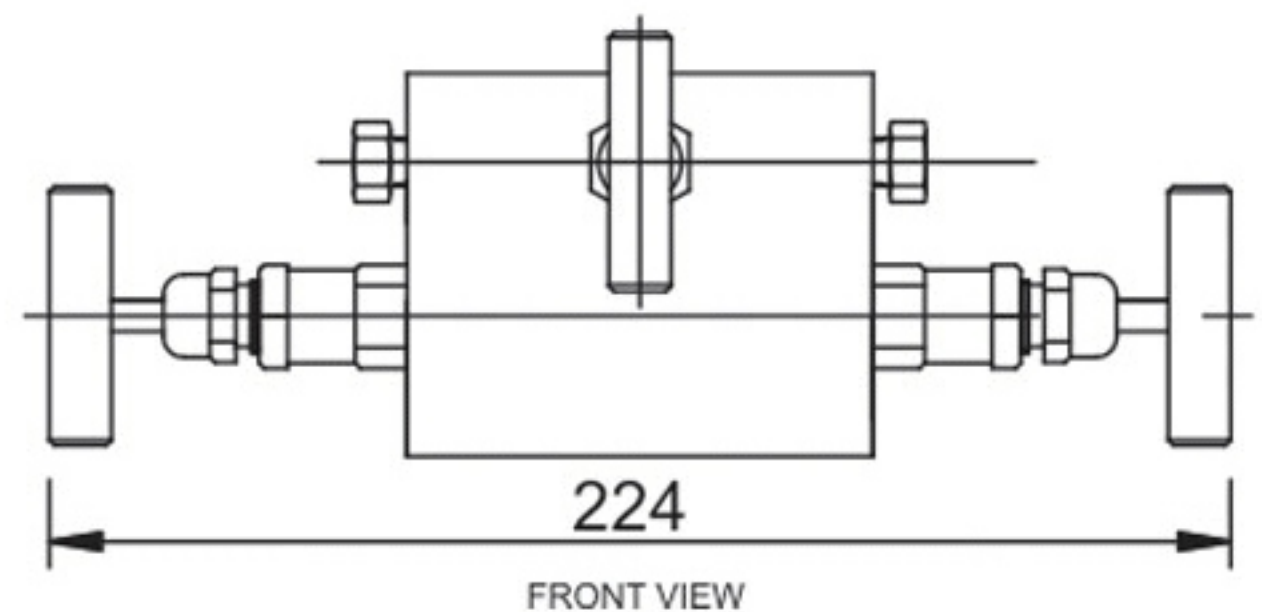
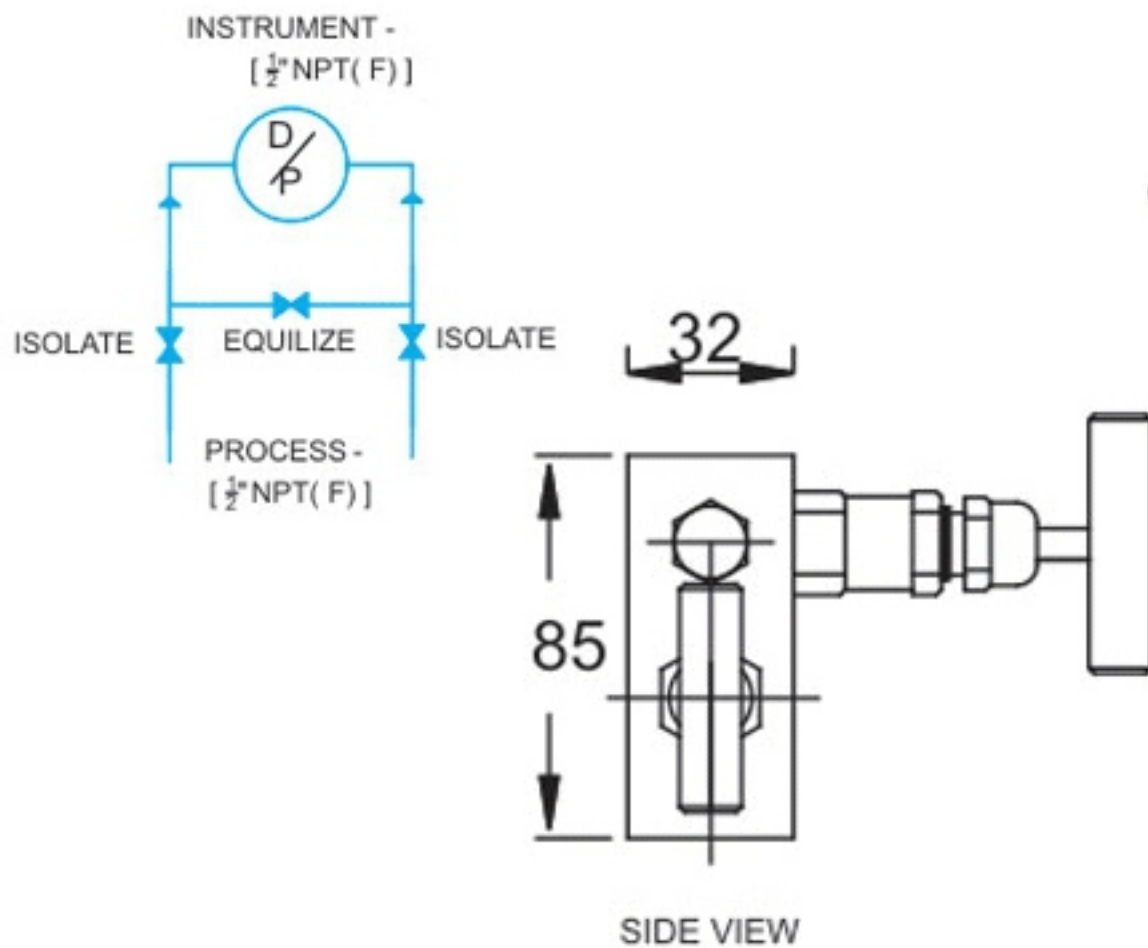
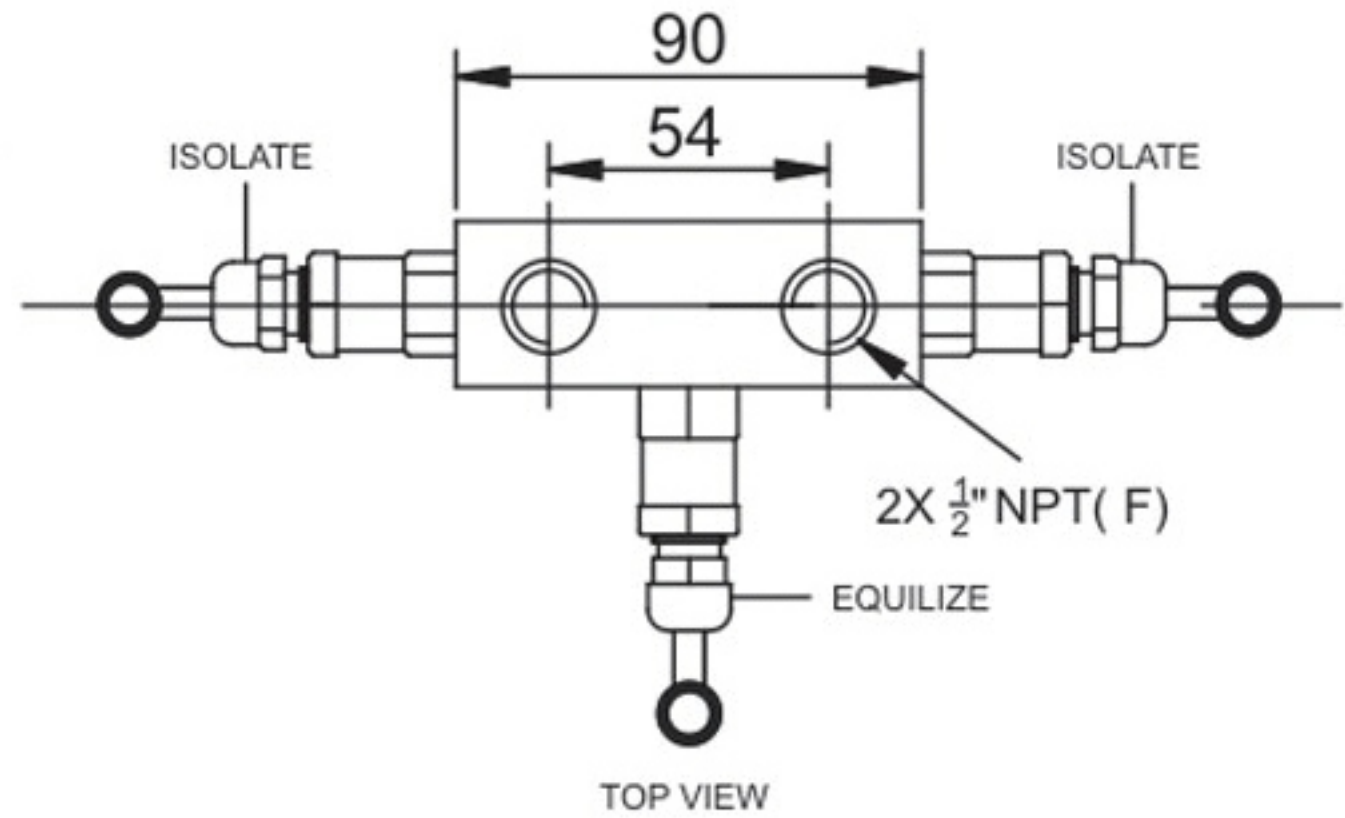

NOTE: ALL DIMENTIONS ARE IN MM. DIMENTIONS ARE FOR REFERENCE ONLY & SUBJECTED TO CHANGE

DRN.BY. JAIM	DATE :	CLIENT :	ITEM :	 PMT ENGINEERS Naroda- Ahmedabad- 382330 E-Mail : info@pmtengineers.com pmtpanchal@yahoo.co.in Web : www.pmtengineers.com
CHD.BY.	ISSUE NO.	NAME :	APPD.BY PART NO. :	
APD.BY.	ISSUE DATE :	DESIGNATION :	QTY : _____ NOS.	
		SIGN & STAMP :	MATERIAL :	